

**BOXMET**

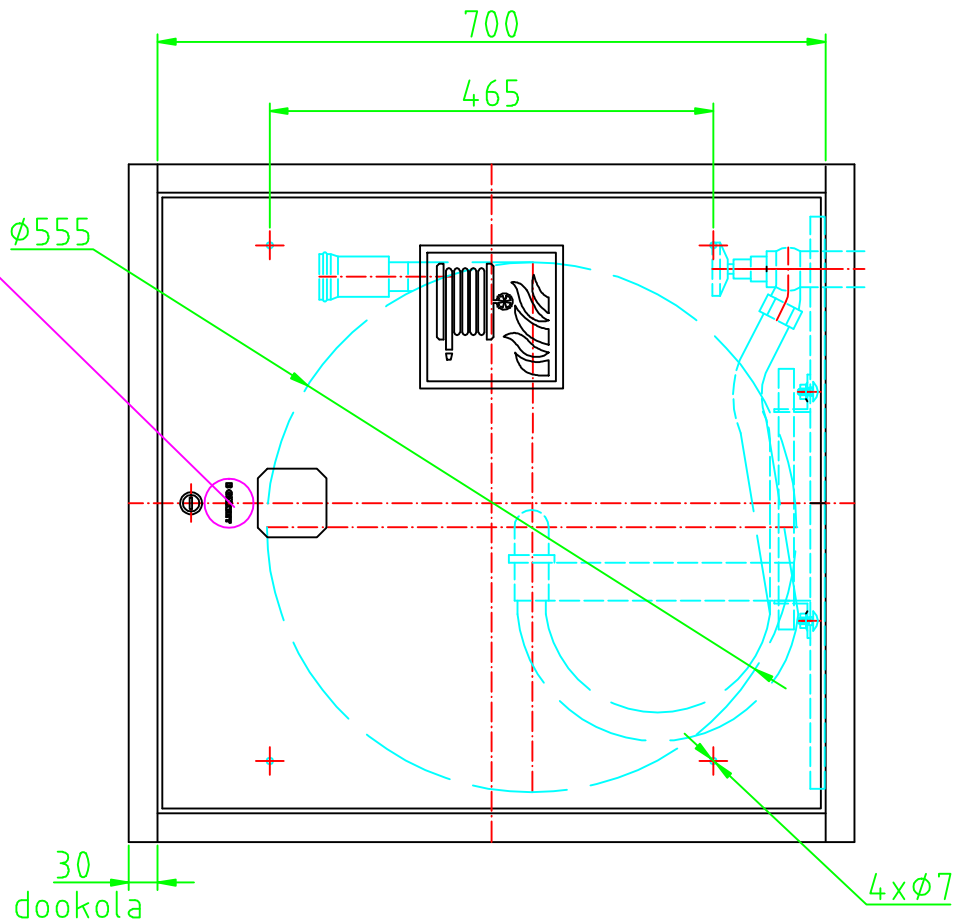

Material	Nazwa	Ilość	Nr rysunku
	<i>Hydrant wewnętrzny DN25x30</i>		<i>H25-W-30</i> <i>650x700x250</i>
Konstr.			